

SIROCLAVE B

Operating Instructions (Mod. 03)

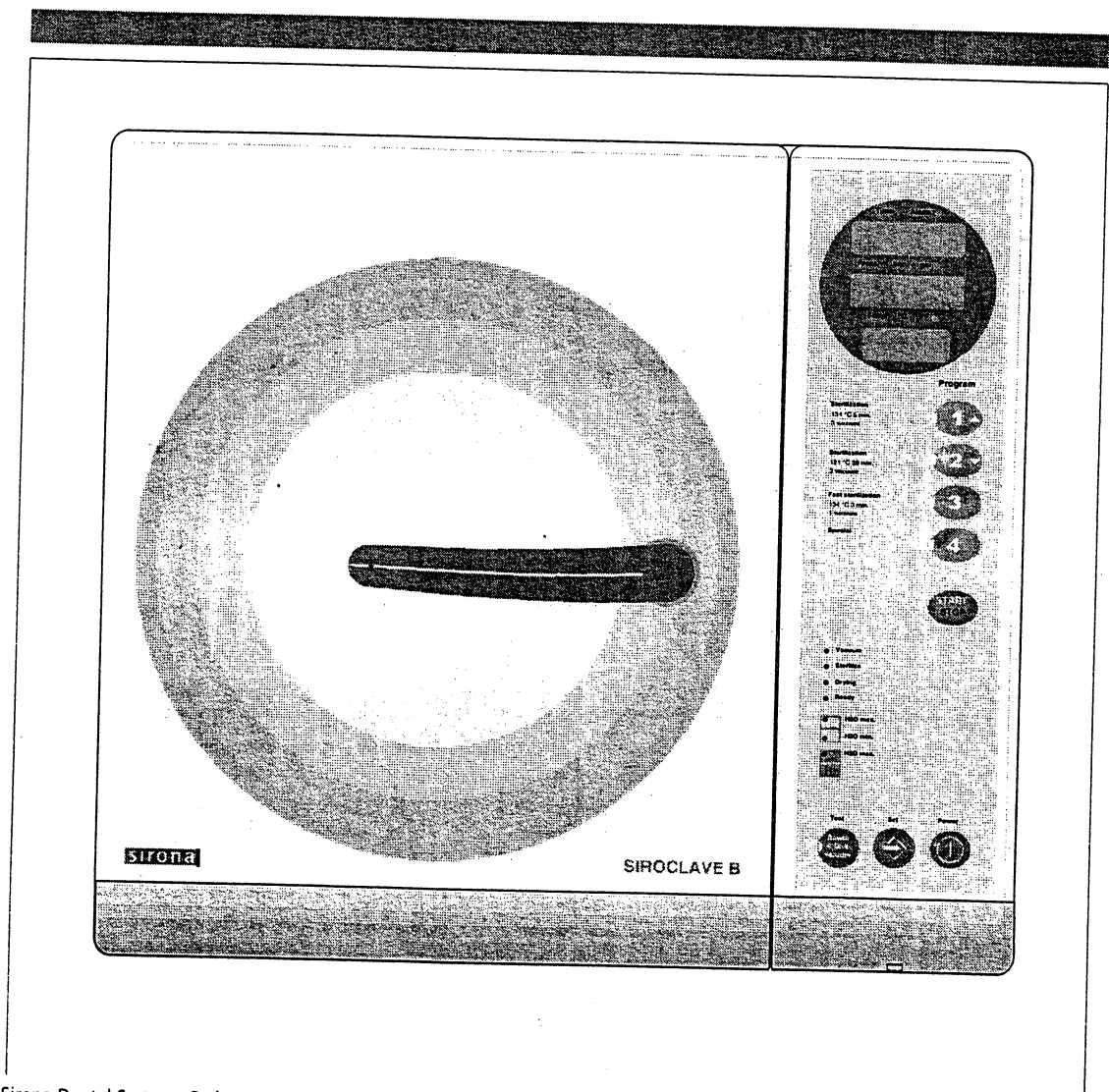

SIROCLAVE B

Operating Instructions

SIROCLAVE B fulfills all the directions in force concerning the safety, and the built-in parameters has been properly set by the manufacturer in order to warranty effective sterilization if proper loading conditions are followed. Please, read carefully this manual before using the machine; an improper utilization of the sterilizer should carry on defective sterilization with unattended consequences.

In case of doubt or questions, please call the agent.

Thanks for the confidence given.

ENGLISH

All rights reserved

No portion of this publication can be printed, transmitted, rewritten, stored in a data recovery system, translated in any foreign or computer language, in any form or through any devices, without written consent by Sirona Dental Systems GmbH.

Information in this manual is subject to change without any warning or prior notice and does not represent a commitment for the vendor.

sirona

The Dental Company

Fabrikstraße 31
D-64625 Bensheim - Germany
Tel. +49 6251 16-1616
Fax +49 6251 16-1818
e-mail: product.service@sirona.de
<http://www.sirona.de>

SERVICE
Tel. +49 6251 16-1616

TABLE OF CONTENTS

1. GENERAL	4
1.1 FOREWARDS.....	4
1.2 CONFORMITY TO EUROPEAN DIRECTIVES.....	4
2. TECHNICAL SPECIFICATIONS	5
2.1 PACKAGE DIMENSIONS AND WEIGHT.....	5
2.2 PHYSICAL CHARACTERISTICS.....	5
2.3 CHAMBER DIMENSIONS AND CAPACITY.....	5
2.4 SAFETY FEATURES.....	6
2.5 DEVICES OF THE STERILIZER.....	7
2.6 STANDARD ACCESSORIES.....	8
2.7 TECHNICAL DATA.....	8
2.7.1 Environment operating conditions.....	8
3. INSTALLATION	9
3.1 BASIC REQUIREMENTS.....	9
3.2 PRELIMINARY STEPS.....	10
3.3 NOTES ABOUT THE ALTITUDE COMPENSATION.....	11
4. OPERATION	12
4.1 FRONT PANEL.....	12
4.2 CYCLE SEQUENCE.....	13
4.2.1 Program selection.....	13
4.2.2 Running the cycle.....	14
4.3 STOPPING THE CYCLE.....	15
4.4 TOPPING UP THE MAIN TANK - DRAINING THE USED WATER TANK.....	16
4.4.1 Topping up the main tank.....	16
4.4.2 Draining the recovery tank.....	16
4.5 SOUND WARNING SIGNALS.....	16
5. PROGRAMMING	17
5.1 SETTING DATE AND TIME.....	17
5.2 SETTING MEASUREMENT UNIT AND OPTIONS.....	17
5.3 SETTING THE SPECIAL CYCLE S5.....	18
6. MAINTENANCE	19
6.1 PERIODIC CLEANING CYCLE.....	19
6.2 CLEAN THE INSTRUMENTS BEFORE.....	19
6.3 H ₂ O FILTER MAINTENANCE OR REPLACEMENT.....	20
6.4 REGULAR STERILITY CHECKS.....	21
6.4.1 Bowie & Dick Test.....	21
6.4.2 Vacuum Test.....	21
7. TROUBLESHOOTING	22
7.1 MANUAL DIAGNOSIS.....	22
7.2 AUTOMATIC TROUBLESHOOTING.....	23
7.2.1 Water quality check.....	23
8. ALARMS	24
8.1 WARNING MESSAGES.....	24
8.2 PRE-WARNING ALARMS.....	25
8.3 ABORTED CYCLE ALARMS.....	26
8.4 CLASS B ADDITIONAL ALARMS.....	26
9. CONNECTIONS	27
9.1 PRINTER CONNECTION.....	27
9.2 PC CONNECTION.....	27

1. GENERAL

1.1 FOREWARDS

Object of this manual is to supply the instructions for the operators in order to allow:

- the correct installation
- the right use
- the proper maintenance of the sterilizer

The machine must be installed and operated according to the procedures described in this manual.

The user is responsible for what concerns the fulfillment in the legal subject concerning the installation and the operation of the sterilizer.

 **We draw your attention to the fact that this Class IIa medical device must be maintained in safe operating conditions through a yearly inspection.**

If the machine is not correctly installed and operated or a not appropriate maintenance is carried out, the manufacturer cannot be considered responsible for any possible breaks and malfunctions.

Please, check for the packing integrity and no evident damages or missing parts (see delivery note).

 **IN CASE OF DAMAGES OR MISSING PARTS, PLEASE IMMEDIATELY INFORM AND IN DETAIL THE FORWARDER, SIRONA DENTAL SYSTEMS GMBH AND ITS AREA AGENT.**

1.2 CONFORMITY TO EUROPEAN DIRECTIVES

SIROCLAVE B complies with the electromagnetic compatibility standards in conformity with the 93/42/CEE for medical devices and with prEN 13060/1 and 13060/2 for class B sterilizers.



Mark CE 0123 applied on the rear panel points out the conformity with the Directive 93/42/CEE and warrants the customer that the equipment is safe and according with the international standards.

2. TECHNICAL SPECIFICATIONS

2.1 PACKAGE DIMENSIONS AND WEIGHT

Package weight: 67 Kg
Store the package for future shipment.

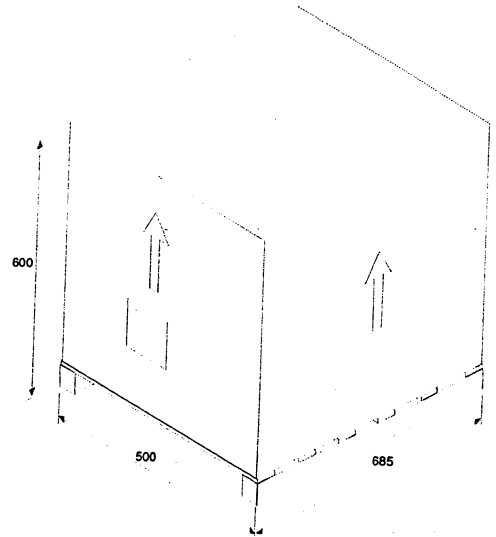

2.2 PHYSICAL CHARACTERISTICS

EXTERNAL DIMENSIONS AND WEIGHT

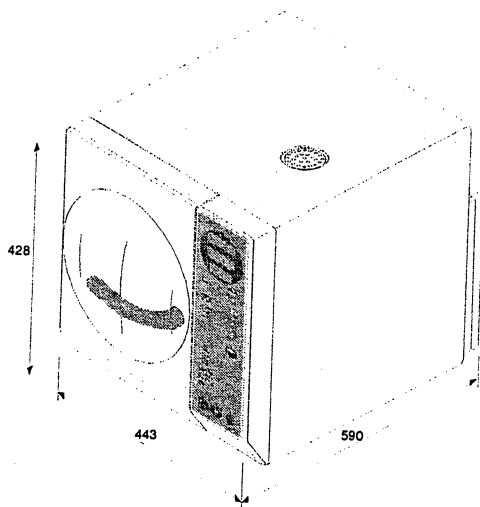

Net weight: 55 Kg

USEFUL DIMENSIONS

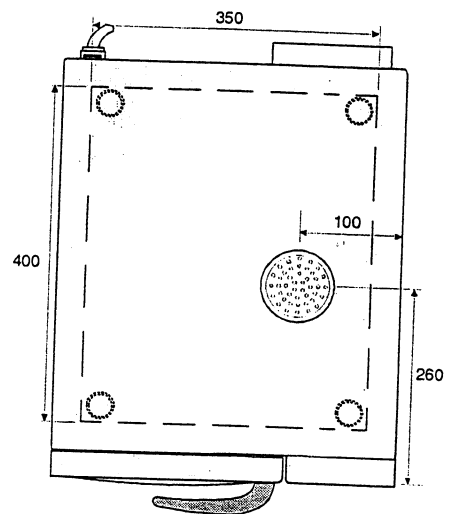

Minimum dimensions for the support plane:
350x400mm.

2.3 CHAMBER DIMENSIONS AND CAPACITY

Diameter:	240 mm
Depth	384 mm
Capacity	18 liters

ENGLISH

2.4 SAFETY FEATURES

SIROCLAVE B provides several safety features:

Double door lock mechanism

Chamber can be opened only when internal pressure is at atmospheric value.

Double Safety Pressure System

- **Safety valve** - The safety valve opens as backup protection to reduce chamber pressure in the event pressure exceeds 2,6 bar.
- **Vent valve** - If chamber pressure should exceed 2,4 bar the vent valve will open and the ALARM 10 will be displayed.

Overheat Protection

Chamber temperature is set so as not to exceed 142 °C and has an additional overheat protection if temperature reaches 150 °C.

Electrical Power Interruption "Black Out"

In case of an mains failure during the sterilization cycle, the pressure in the chamber is automatically vented up to the atmospheric value.

As the power returns, message **BLACK OUT** will be displayed.

Automatic switch-off

At the end of a cycle the sterilizer turns off automatically after a period of 30 minutes if no program keys are activated or the door opened.

Class B

prEN13060-1/2

ENGLISH

2.5 DEVICES OF THE STERILIZER

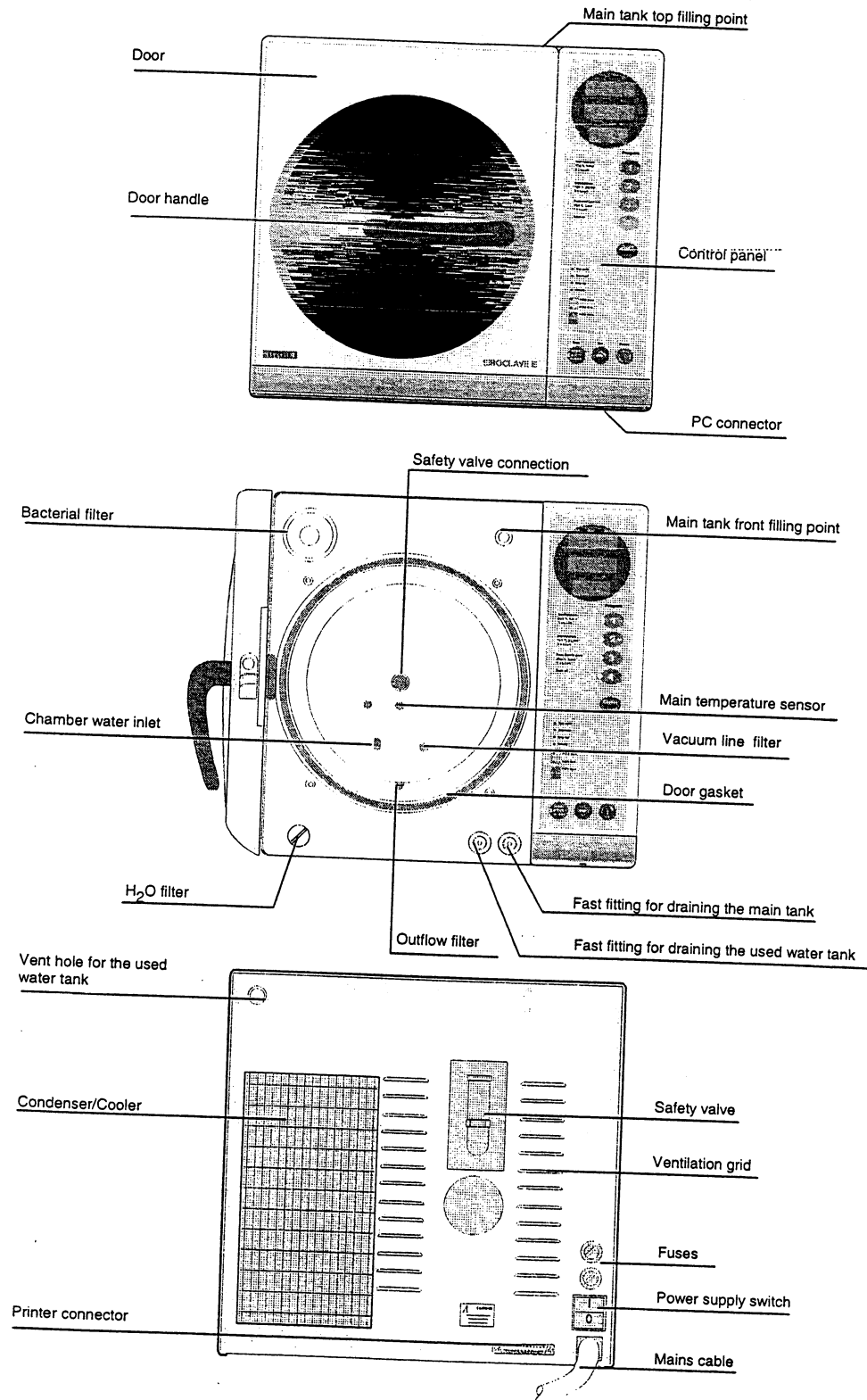

ENGLISH

2.6 STANDARD ACCESSORIES

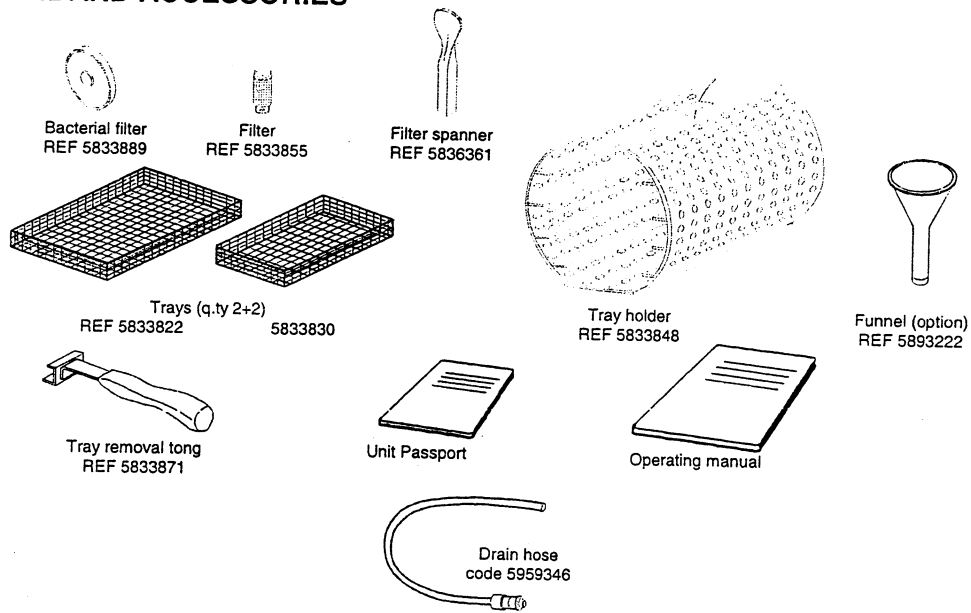

ENGLISH

☞ Before installing the machine, verify all the accessories and that the Unit Passport is correctly signed. To make the warranty active it is necessary that a copy of the supplied Unit Passport is sent, through the agent, to the manufacturer; for want of this the warranty will decline.

2.7 TECHNICAL DATA

Chamber dimensions	Ø 240 mm, depth 384 mm	Auto-switching-off	The machine switches-off elapsed 30 min. after the end of a cycle
Chamber capacity	18 l	Dual water tank	4 liter each
Maximum load	4 kg (solid instruments) 1,5 kg (porous instruments)	Vacuum pump	20 l/ min. - 0.97 bar
Warming-up time	20 min. starting from room temperature 10 min. starting from chamber pre-heated	Bacterial filter	0,3 µm at 99.97 % certification 21 (see 820 FDA) autoclavable
Sterilization time	from 3 to 90 minutes, depending on the selected cycle	Differential heating system - SDR	
Drying time	from 3 to 14 minutes, depending on the selected cycle	Class B – prEN13060	
External dimensions	443 x 590 x 428 mm (L x D x H)	3 LCD displays and signaling LEDs	
Net weight	55 Kg	Soft-touch diaphragm key	
Power supply voltage	200 – 250 VAC	10 different programs: - 2 for test - 6 for sterilization - 1 for disinfection - 1 individual program	
Frequency	50 Hz	Door with double insulating layers and safety lock	
Max consumption	1920 W	Control of the water quality	
Average consumption	1000 W		
Standby consumption	1 W		
Fuses	2 x 10 AT (type 6.3 x 32 CT) - IEC 127		

2.7.1 Environment operating conditions

SIROCLAVE B has been designed to operate at the environmental conditions between 3°C and 45°C, H.R. lower than 95%, and pressure from 750 mBar to 1050 mBar.

3. INSTALLATION

3.1 BASIC REQUIREMENTS

1. Make sure that the features of the electric plant is according with the requirements indicated on the rear plate, the power supply socket should provide at least 10 A and adequate earth connection.



The manufacturer disclaims any responsibility for damage caused by inadequate or not earth-connected electrical plant.

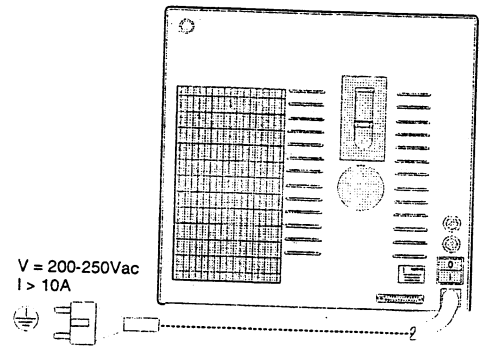

2. The sterilizer should be slightly tilted to facilitate water outflow during the steam draining phase. For this reason, the equipment is delivered with feet already set; if necessary adjust the front feet.

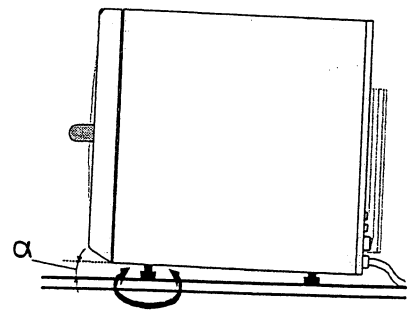

3. To warrant the correct working of the sterilizer it is imperative that the rear and lower panels are not clogged and that the unit is not installed in extremely moist environments or arranged close to inflammable gas sources.

4. The distance from the rear wall should be at least 4 cm.

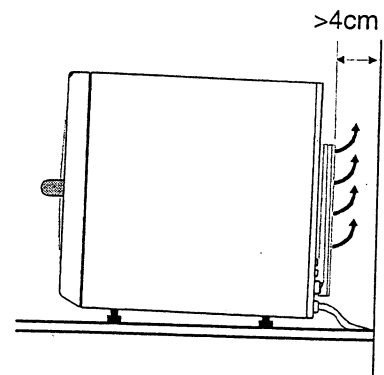

The sterilizer may be installed recessed, as long as adequate free space around the unit (> 10cm) is guaranteed.

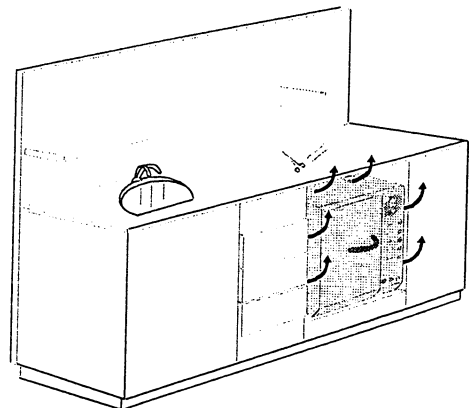

ENGLISH

3.2 PRELIMINARY STEPS

 These adjustments should be carried out only by qualified service technicians. Incorrect settings might effect the quality of sterilization.

1. Verify that the electric plant meets the equipment requirements; plug the power supply cable into an AC socket.
2. The sterilizer is delivered without water into the tank; before proceeding it is necessary to fill the tank with demineralized water.

 Poor-quality water might lead to calcareous deposits on the instruments, chamber walls and trays. Read the label carefully before using the water. **Tap water must never be used**, even if conditioned through filters or softeners.



Never use battery distilled water bottles as the sulfuric acid added will cause irreversible sterilizer's damage.

Fill completely the distilled water tank.

3. Turn-on the sterilizer by the rear power supply switch. This should preferably be kept in "on" position, as in stand-by status the power consumption is very negligible.

4. Take basket and trays out of the chamber and close the door.

5. Hold pressed the key **1** and select the key **POWER**; the display will show <SET ALT 100 MT> (100 is the factory-set standard altitude value).

Modify the value according to the current installation altitude (see next page) by operating on the keys **1** or **2**.

Then press the key **SET** to store the set value and to start the automatic procedure for the first water filling of the hydraulic circuit and the chamber itself.

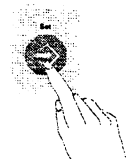
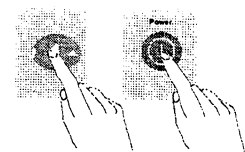
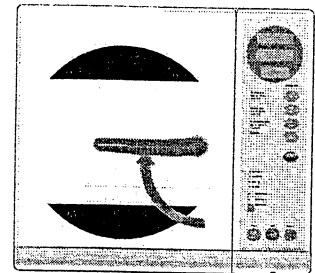
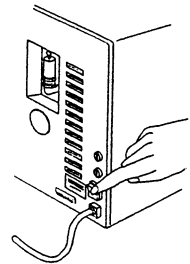
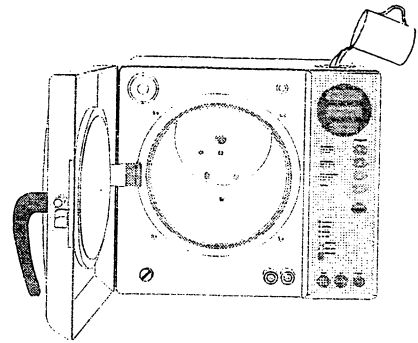

6. At the turning on of the signaling **READY**, open the door and wipe the chamber with a clean cloth.

In case of wrong procedure or incorrect condition, the display will show one of the following warnings:

- DOOR OPEN:** the door must be closed
ADD H₂O: the tank must be filled
NEED INST: failed or missed installation procedure. Repeat the procedure from the step 5.

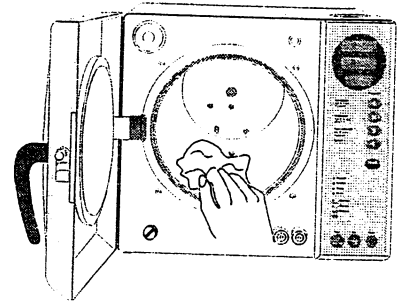

Now the sterilizer is ready for the first sterilization cycle.

Position the tray holder and the trays with the load to be sterilized in the chamber and select the first sterilization cycle.

The operating instructions are detailed on chapter 4 "OPERATION".

3.3 NOTES ABOUT THE ALTITUDE COMPENSATION

To ensure the correct operation of the sterilizer's pressure transducer the equipment must know the environment data in order to allow the necessary pressure compensation.

The correct altitude value (above sea level) must be set at the first installation and in case the sterilizer is moved at altitude differing from the set value.

The factory-set value is 100 meters. If the actual altitude is between 0 and 200 meters no adjustment is needed. Differences of ± 100 meters do not affect the correct sterilizer operation.

To ensure the right sterilization verify that the altitude value set during the installation does not differ from over 200 meters from the current one. An incorrect altitude setting may result in a prolonged vacuum cycle and/or false or premature AL8 and AL5 error messages.

 THESE ADJUSTMENTS SHOULD BE CARRIED OUT ONLY BY QUALIFIED SERVICE TECHNICIANS. INCORRECT SETTINGS MIGHT EFFECT THE QUALITY OF STERILIZATION.

4. OPERATION

4.1 FRONT PANEL

All controls and displays are on the front panel. The panel being slightly tilted, displays are clearly visible and controls can be readily operated.

The touch-sensitive keys enable and control all functions of the sterilizer.

Displays and Led's : Visualize the parameters of the different cycle phases and other useful information on the unit operation; the upper display shows time values or alarm codes (signaled by the Led Time or the Led Alarm) – the middle display shows the pressure values (bar or psi unit) – the lower display shows the temperature values (°C or °F unit). The associated Led indicates the measurement unit.

Program selection keys : The first three recall different pre-set programs, the last recalls 4 special pre-set cycles, plus 1 programmable by the operator. Each key has own signaling Led.

- 1 Sterilization 134°C, 5 min., 3 vacuum phases:
for all instruments (wrapped or unwrapped)
- 2 Sterilization 121°C, 20 min., 3 vacuum phases:
for porous instruments and textiles
- 3 Fast sterilization 134°C, 3 min., 1 vacuum phase,
for solid unwrapped instruments
- 4 Four pre-set special cycles (S1, S2, S3 and S4) + one special cycle
(S5) programmable by the operator

Key **Start/Stop**: starts or stops the cycle after it is running.

Led of the current phase: lights or flashes during the phases.

Led H2O max/min: lights for main tank full or empty.

Led H2O max : lights for used water recovery tank full.

Key **Power**: activates the control board and display panel, the switching-on autotest and the heaters for the pre-heating process.

Key **Set**: allows to set current date/time, measuring unit, printout language, and temperature/time/number of the vacuum phases for the programmable cycle.

Key **Test**: allows to carry out Bowie & Dick Test if the sterilizer is active, or Vacuum Test if the sterilizer is in stand-by and the chamber temperature lower than 35°C. The key has own signaling Led.

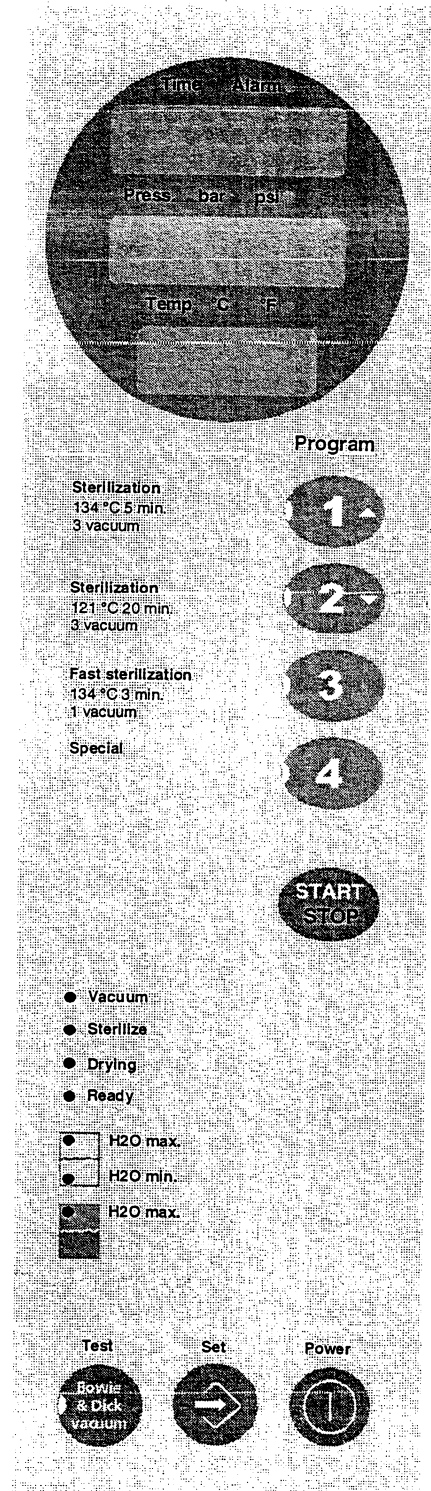

4.2 CYCLE SEQUENCE

1. Press the switch on the rear panel to power the sterilizer.
 - "TIME" display shows the current date and time
 - "PRESS." display shows day and month
 - "TEMP" display shows OFF
2. Press key **POWER** on the front control panel and wait a few seconds for the automatic autotest completion; during this period the set-points of the parameters and the check-up of the main assemblies will appear in sequence on the display. Ended the autotest, the upper display "TIME" will show again the current time, the display "PRESS" the pressure into the chamber, the display "TEMP" the chamber temperature (or the message "Low" if lower than 35°C). The pre-heating process starts and the microprocessor drives the heaters at reduced power in order to set the chamber surface temperature up to about 100°C.

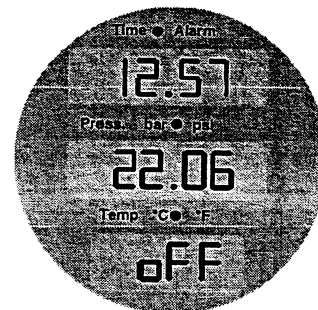

 During this phase the temperature reading on the display is inaccurate, because no steam being there.

3. Arrange the material to be sterilized on the trays, load the tray into the chamber and close the door.
4. Verify that the red Led MIN of the main tank is off. If not fill up the main tank with demineralized water up to the lighting of Led MAX.

4.2.1 Program selection

AVAILABLE PROGRAMS

Key	Program	Parameters	Load type
1	STERILIZATION	134°C 5 min. 3 pre-vacuum phases drying 10 min. (6 vacuum + 4 ventilation)	Every load type that could be submitted to 134°C (Helix Test)
2	STERILIZATION	121°C 20 min. 3 pre-vacuum phases drying 11 min. (7 vacuum + 4 ventilation)	Every load type that could be submitted to 121°C (Helix Test)
3	FAST STERILIZATION	134°C 3 min. 1 pre-vacuum phase drying 3 min. (2 vacuum + 1 ventilation)	Solid unwrapped instruments
4	SPECIAL S1 disinfection	105°C, 8 min. 3 pre-vacuum phases, drying time 7 + 4 min.	Items which are only resistant up to 105°C
	S2 big load	134°C, 5 min. 4 pre-vacuum phases, drying time 8 + 5 min.	Critical instruments
	S3 big load	121°C, 20 min. 4 pre-vacuum phases, drying time 8 + 5 min.	Very critical instruments
	S4 Prions	135°C, 19 min. 3 pre-vacuum phases, drying time 6 + 4 min.	Creutzfeld-Jacob/mad cow disease
	S5 custom	Parameters set by the operator: Temperature: 105 ÷ 135°C Time: 3 ÷ 90 min. Pre-vacuum: 1, 3 or 4 phases Drying + Ventilation time: 3+2, 6+4 or 8+6 min.	It depends on the selected parameters
Test	Bowie & Dick Test	134°C, 3.5 min., 3 vacuum phases	B&D tests (3M™ COMPLY™ code 1300)
	Vacuum Test	Temperature under 35°C	No load

To select the program **1**, **2** or **3** press on the relating key.

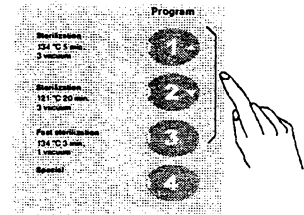

To select one of the programs of the option **4**, hold pressed the key **4** and select the key **1** or **2** to display the choice (S1, S2, S3, S4 or S5) on the middle display.

The displays will show for 5 seconds the preset parameters of the selected cycle.

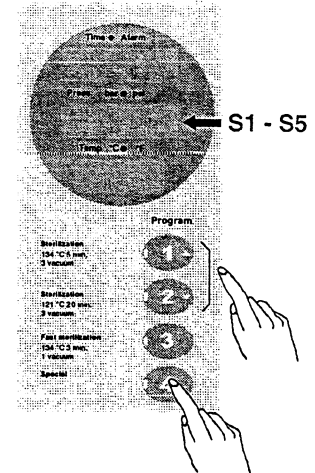

ENGLISH

4.2.2 Running the cycle

Press the key **START/STOP** to start the selected program.



Programs **3**, **S1** and **S5** do not grant a class B sterilization; to start these type of programs previously selected, hold pressed the key **3** (or **4**) and select the key **START/STOP**.

Once again the preset parameter values of the selected program are displayed for 10 seconds, then the sterilizer starts to run automatically in sequence the phases of the cycle. The various steps of the cycle are microprocessor controlled and sequentially shown on the display; in this way the operator can monitor the cycle phases and times.

- Led **VACUUM** turns ON
- Upper display **TIME** starts recording the cycle duration
- Display **PRESS** shows the pressure
- Display **TEMP** shows the temperature
- The Led on the program key selected starts to blink

In this first phase the microprocessor enables the vacuum pump and supplies a water dose into the chamber. The Led **VACUUM** flashes. This phase will be repeated more times and should require 10 to 20 minutes depending on the chamber conditions and the type of material to be processed. Pump operation may be slightly noisy.



For unwrapped solid instruments we recommend to use the cycle 3. In this way the sterilization time will be faster, and power consumption reduced.

Reached the pre-set parameter values, Led **VACUUM** turns OFF, and Led **STERILIZE** turns ON. The upper display starts the countdown marking the remaining time for the sterilization process; the other displays are showing the steam temperature and pressure values.

VACUUM phase (chamber water filling and pre-vacuum phases)

STERILIZATION phase

Ended the sterilization phase, starts the decompression phase, with the PRESS display showing the decreasing pressure values down to 0. Again, the display TIME will start the countdown of the decompression phase. Based on previous experiences, the decompression time has been slightly extended in order to minimize the thermal shock consequent to the steam changing its state.

When decompression is through, Led **STERILIZE** starts to flash to signal the process has been completed. At the same time Led **DRYING** turns ON, signaling the start of the drying cycle. Throughout this phase, the heaters hold the chamber warm according to a microprocessor-controlled differentiated logic, the vacuum pump comes into operation again to suck in all residual steam. Display TIME shows the countdown of this phase.

Follows the forced ventilation through the bacterial filter; the countdown of this phase is signaled on the display TIME.

Ended the drying phase, Led **DRYING** turns OFF and Led **READY** and **STERILIZE** turn ON. A 10-second alert signal is generated to draw the attention by the operator. The heaters are switched to a reduced power until the door is open. Display TIME will show the total time of the cycle, and the displays TEMP. and PRESS the chamber current temperature and pressure.



At the end of the cycle 3, S1 or S5, only Led **READY** will light (not the Led **STERILIZE**) to signal that the cycle selected by the operator does not grant a class B sterilization.

The process is over and the instruments can be downloaded.



*Be careful !,
both instruments and chamber are hot !*

Opening the door, the displays will show again the current time, chamber temperature and pressure, and the sterilizer is ready for a new cycle.

If a printer is connected and ready, a report will be issued during the cycle phases with significant information, allowing a proof of the sterilization process.

The operator can arrange a new load and start a next sterilization cycle, taking the advantage of shorter warming-up time as the chamber is already warm, or press the key **POWER** to switch in stand-by status the unit (OFF status).

If the door is not opened or no key is pressed within 30 minutes from the end of the cycle, the sterilizer will switch automatically in stand-by (OFF status).

Should any failure or error occur during the cycle, Led **ALARM** turns ON and the upper display will show the alarm type and code (see chapter ALARM).

DRYING phase

END – Led **READY** and **STERILIZE** turn ON

ENGLISH

Time () Alarm ●



4.3 STOPPING THE CYCLE

To stop the sterilization cycle, press the key **START/STOP**.

The upper display will show **MANU STOP**.

Before opening the door, make sure that the pressure value shown on display PRESS is equal to zero. A safety device will anyway prevent from opening the door if the chamber is over-pressurized.

Remove the instruments and check for the presence of water into the chamber. In case of wrapped instruments, we suggest to replace with new bags.

In case of residual water in the chamber, wait 10 minutes before loading again the chamber so as to allow the water to evaporate and be drained. Wipe the chamber with a clean cloth.



4.4 TOPPING UP THE MAIN TANK - DRAINING THE USED WATER TANK

The sterilizer is fitted with two 4-liters tanks: main tank for the demineralized water and recovery tank for the used water.

The hydraulic system does not reuse the steam generated during the sterilization process; this steam is collected in a recovery tank that must be periodically drained. This mode of operation involves the progressive emptying of the main tank and the filling of the recovery tank.

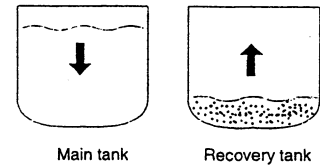

4.4.1 Topping up the main tank

The average water consumption for any sterilization cycle is 520 cc, so 7 cycles can be performed by the tank fully loaded.

The lighting of Led MIN signals the operator that the water level in the main tank is insufficient to perform a new process.

Provide for the topping up of the main tank, taking care to not exceed the limit of the hole's grid. The lighting of Led MAX and 7-beep signal warns that the tank is full.



4.4.2 Draining the recovery tank

The lighting of Led MAX relating the recovery tank warns that the overflow limit has been reached. In this case:

- Get a bucket or a tank with a capacity of at least 4 liters,
- Fit the draining hose into the gray-colored fast fitting (unthreaded side),
- Wait until the water has been completely drained,
- Unfit the hose pushing the ring nut against the machine and drawing the hose.

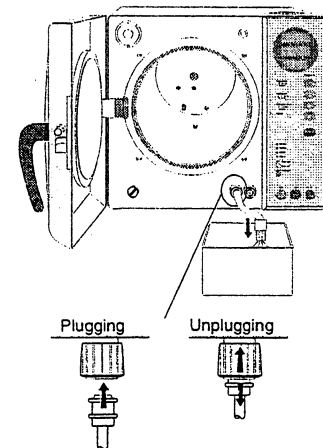

4.5 SOUND WARNING SIGNALS



In order to make SIROCLAVE B operation even simpler and more user-friendly, some acoustic signals are generated to draw the attention of the operator at the main steps of the sterilization cycle or at the occurring of an alarm:

- Whenever a key is pressed, a short beep is generated.
- 3 beeps signal the end of the switching-on autotest.
- 10 beeps signal the end of the sterilization process.
- 1 intermittent beep signals that the door has not been properly closed.
- 30-seconds beep warns the operator in case an alarm occurs during the cycle.
- 7 beeps signal that the main tank is full.

5. PROGRAMMING

5.1 SETTING DATE AND TIME

Press key **SET** and use arrow keys 1 and 2 (arrow ▲ or ▼) to fine adjust the values. Whenever the key **SET** is pressed, a different function is enabled:

PRESS IN A SEQUENCE	ON THE "TIME" DISPLAY	PARAMETER TO BE ADJUSTED	USE KEY  to increase the value, or  to decrease the value
SET	SET YEAR	YEAR	
SET	SET MONTH	MONTH	
SET	SET DAY	DAY	
SET	SET HOUR	HOUR	
SET	SET MIN	MINUTES	
SET	Exit the programming mode		

Example: to adjust the current hour, press key **SET** four times and set the time by using the arrow key (1 or 2).

5.2 SETTING MEASUREMENT UNIT AND OPTIONS

Press keys SET and 3 sequentially to access the setting mode	The display PRESS shows: <i>SET UNIT °C</i> or <i>SET UNIT F</i> The display TIME shows: <i>L1</i> <i>L2</i> <i>L3</i> <i>L4</i> <i>L5</i> <i>L6</i>	Use key 1 to set the desired temperature measurement unit Press more times key 2 <i>L1 = Italian</i> <i>L2 = English</i> <i>L3 = Spanish</i> <i>L4 = French</i> <i>L5 = German</i> } to set the language of the printing report <i>L6 = saving the sterilization cycle data on PC (through a link with an external optional interface)</i>
Press key SET	display PRESS shows: <i>SET UNIT BAR</i> or <i>SET UNIT PSI</i>	Use key 1 to set the desired pressure measurement unit
Press key SET to exit the programming mode		

The sterilizers are generally factory pre-set for the measurement unit and options used in the destination countries (°C, bar and L2).

5.3 SETTING THE SPECIAL CYCLE S5

The operator can set a special customized sterilization cycle as follows:

Press keys SET and 4 in a sequence	The display press shows: <i>SET TEMP</i>	Set the process temperature value between 105 and 135 °C through keys 1 and 2
Press key SET once again	The display press shows: <i>SET TIME</i>	Set the process time between 3 and 90 minutes through keys 1 and 2
Press key SET once again	The display press shows: <i>VAC</i> or <i>DRY</i>	Set the number of vacuum phases (1, 3 or 4) by key 1 ; the value is shown close to message <i>VAC</i> . Set the duration of the drying phase (vacuum + ventilation = 3+2, 6+4 or 8+6 minutes) by key 2 ; the value is shown close to message <i>DRY</i> .

Press key **SET** again to exit the programming mode. The parameter values of the **SPECIAL** cycle are automatically stored and maintained until new values are set through the same procedure.



Depending on the time + temperature value combination selected by the operator, the processed cycle may differ from class B sterilization program. We recommend to test the sterilization performance by means of adequate procedures. At the end of the cycle **S5**, only **Led READY** will turn on (not **Led STERILIZE**) to signal that the efficiency of the cycle selected by the operator has not been tested by the manufacturer.

ENGLISH

6. MAINTENANCE

6.1 PERIODIC CLEANING CYCLE

A proper maintenance program is an essential prerequisite for the smooth running of the sterilizer. To this regard, it is important to carry out the following cleaning cycle at least every month.

 Every 60 cycles the sterilizer will display the warning
<NEED CLEANING >.

1. Put in stand-by mode the sterilizer by pushing on the key **POWER** (OFF on the display).
2. Take the basket and the trays out of the chamber and wash them with an ordinary dish washing powder, then rinse with water and wipe them.

 **DO NOT USE ABRASIVE DETERGENTS**

3. Put one cleaning tab into the chamber and close the door.

4. From standby status, hold pressed the key **START/STOP** and press the key **POWER** to start the automatic cleaning cycle. This cycle takes about 15 minutes.

5. After the end of the cycle, the Led **READY** will turn on. Open the door and wipe the chamber with a clean cloth slightly soaked with demineralized water and pure alcohol. Do not use sponges, brushes, abrasive steel wool or paper.

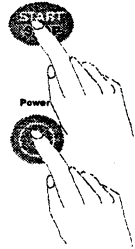
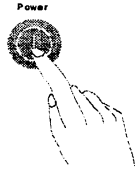

Hold down

Cleaning Tablets kept in cupboard in clean up Room

order cleaning Tablets Through SIRONA

and Press Power at same time

ENGLISH

6.2 CLEAN THE INSTRUMENTS BEFORE

In order to extend the sterilizer life, we recommend to carry out an accurate cleaning of instruments, as one of the main causes of an early wear of the unit is the settlement and accumulation of debris and fragments for an inadequate cleaning of the instruments. A consequent stains, fouling and progressive clogging of filters, electrovalves and hydraulic circuits will occur.

We remind you that the electronic control system tracks and stores the number of maintenance cycles actually performed.

The lacking of appropriate and regular maintenance according to the above guidelines may require early service activities and involve the warranty lapse.

6.3 H₂O FILTER MAINTENANCE OR REPLACEMENT

The water filter is located at the left side of the stainless steel front panel; to carry out its cleaning or replacement, proceed as follows:

1. Empty the main tank by plugging the hose (unthreaded end) into the fast fitting located at the right side of the front panel,
2. Use a coin to unscrew the cap closing the filter seat; pay attention for possible overflow of the residual water in the tank connecting internal tube. Unscrew the filter using the supplied spanner,
3. Clean the filter by compressed air (or ultrasonic cleaner) or replace it if the filter is damaged,
4. Reassemble the filter in its seat and the cap by a coin without tightening both excessively,
5. Fill the main tank with demineralized water as for the standard operation of the unit.
6. With the unit in standby state (**OFF** on the display), hold pressed the key  and select the key **POWER**. The equipment will provide for the automatic exhausting of the residual air from the filter. This procedure ends with the lighting of the signal **READY**.

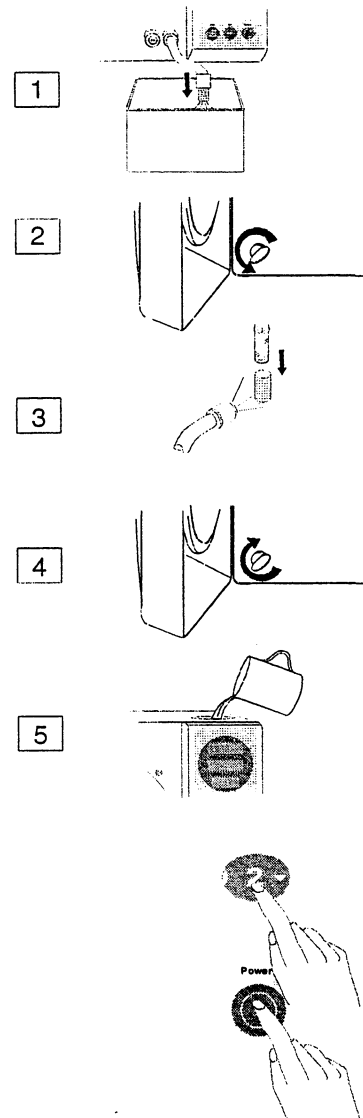

6.4 REGULAR STERILITY CHECKS

For a correct use of the sterilizer, it is advisable to carry out sterility tests regularly. In particular, we suggest to carry out the microbiologic tests, Bowie & Dick and Helix test that may be easily find on the market. For carrying out these tests, refer to the instructions and indications provided by the suppliers.

For the microbiologic tests, we recommend to place biological indicators at different points of the sterilization chamber in order to verify the homogeneity of the sterility conditions. For more information, please call your retailer or Sirona Dental Systems directly.

SIROCLAVE B have been submitted to strict tests of sterility by University of Siena (Institute of Hygiene and Human Anatomy). According to the international standard, all the sterilizers are moreover tested in factory with the above tests.

6.4.1 Bowie & Dick Test

The test can be performed at any time with sterilizer turned on and operating.

- Load the sterilizer with a B&D test (i.e. 3M™ COMPLY™ code 1300) according to the standards for the test procedure.
- With the unit switched-on, hold pressed the key **TEST** and press on the key **START/STOP**.

The test is characterized by the cycle parameters of 3 pre-vacuum phases, 134°C and 3,5 minutes for sterilization temperature and time respectively.

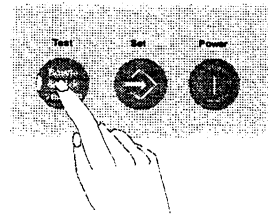

ENGLISH

6.4.2 Vacuum Test

 Take care to carry out the test at the beginning of the working day in order to check the leakproof of the chamber and vacuum system.

The test can be enabled on condition that the machine is in stand-by mode (signaling **OFF** on the display) and the internal temperature is lower than 35°C (normal conditions at the beginning of the day).

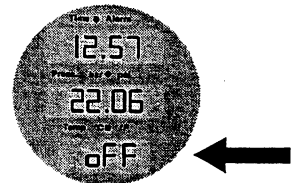

- Press the key **TEST**
- The vacuum test starts automatically and takes about 15 minutes.
- Ended the test, the sterilizer goes back in stand-by mode; press key **POWER** to set for a new cycle.

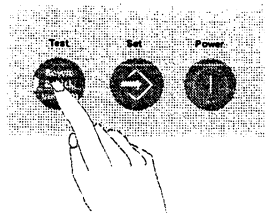

In case of negative result, alarm display will show the signaling **TEST FAIL** to warn for an insufficient vacuum condition in the chamber (see Chapter 8 - Alarms).

7. TROUBLESHOOTING

7.1 MANUAL DIAGNOSIS

The operator can perform at whenever time a test to verify the correct operation of the unit; proceed as follows:

Step 1

Actions	Displayed message
Press keys SET and TEST in a sequence	The displays show respectively: TEST , pressure and temperature values of the chamber
Press key 1	Temperature measurement of the chamber upper wall
Press key 2	Temperature measurement of the chamber lower wall
Press key 3	Message CICL , and total number of the cycles
Press key 4	Message ABOR , and number of the aborted cycles
Press key Test	Number of the cleaning cycles actually performed
Press key Power	Message ALARM , and codes of the last three alarms
Press key Set	Exit to normal mode



During manual troubleshooting the unit cannot be switched off by key **POWER**. The above procedures should be performed by skilled personnel.

Step 2

Actions	Displayed message/Result
Press keys SET and POWER in a sequence	Message TEST OUT shown on the display
Press key 1	Electrovalve 1 energized (open)
Press key 2	Electrovalve 2 energized (closed)
Press key 3	Electrovalve 3 energized (open), electrovalve 5 energized (closed), vacuum pump and drain pump enabled
Press key 4	Electrovalve 4 energized (open)
Press key Power	Electrovalve 5 energized (closed)
Press key Test	Fan of the condenser assembly enabled
Press key Set	Exit to normal mode

7.2 AUTOMATIC TROUBLESHOOTING

Switching on the unit, an automatic 15-sec. duration troubleshooting cycle is started. 3 beeps are generated at the end of this autotest. During this test the main components are sequentially controlled.

If the test is positive, message **Card Good** will be shown. Whatever fault occurs, this is shown on the display and stored according to the alarm codes listed in table C (see chapter ALARM).

To skip the troubleshooting, press any key as soon as the sterilizer is switched-on.

7.2.1 Water quality check

In order to prevent fail due to poor quality of the demineralized water, the Siroclave B is equipped with a special water quality check system.

The control, based on water conductivity measurement, is performed at the switching on of the autoclave and on condition that the machine is cold and the main tank is full.

At the end of the initial autotest the display will show "H2O good" if the conductivity is below 15 μ S and "H2O hard" if above 15 μ S.

ATTENTION

☞ The negative result of the water quality check does not jam the operation of the sterilizer, but we strictly recommend to replace and change the water type.

8. ALARMS

8.1 WARNING MESSAGES

The supervisory system of the sterilizer monitors the phases of the cycle and the operation of the sterilizer's elements. Any possible trouble occurred during the cycle is detected, reported and signaled on the alarm display and by a warning tone.

To make easier the interpretation and identification, the alarms have been divided into four classes, as shown in tables A, B, C and D.

Table A lists the warning messages.

TABLE A

Displayed message	Cause	Recommended action
OPEN DOOR	Door not opened at the end of the cycle. Start command entered with the door open.	Open the door. Close the door
FAIL	Failed cycle	See table C
DRY FAIL	Drying phase not completed due to manual interference (the load has been removed before the drying cycle completion). However the sterilization process has been achieved.	Press key STOP
ADD H2O	Insufficient water in the main tank (the message appears before starting a cycle)	Top up the main tank
FULL H2O	The recovery tank is full (the message appears before starting a cycle)	Empty the water recovery tank
MANU STOP	The cycle has been manually interrupted. The sterilization process has not been completed	Wipe the chamber, and start the cycle again
BLAC OUT	Power supply black-out during the cycle	Verify the AC plug and socket. Dry the chamber and repeat the cycle.
NEED CLEANING	60 cycles without any intermediate cleaning cycle	Perform the cleaning cycle (see Chapter 6.1)
NEED SERVICE	One year from the first installation or over 1500 cycles performed without the service check-up	The warning disappears as soon as a next cycle is selected, but will appear again at the next switching on. Call for a complete check by a qualified technical service; the message will be reset after the servicing.
NEED INST	Need for the installation procedure	Perform the installation procedure (see Chapter 3.2)
NEED TEST	Detected a pre-warning alarm	See table B
TEST FAIL	Negative result of the vacuum test	Clean the door gasket and repeat the test. Call for a technical service

8.2 PRE-WARNING ALARMS

The alarms listed in Table B do not stop the sterilizer operation, but warn that the detected problem might interfere with the correct sterilizer performance.

The trouble should be checked and the recommended action promptly performed.

These alarms are coded and follow the prompt **NEED TEST**.

Example: Need Test cd 1.

TABLE B

Alarm code	Cause	Recommended solution
cd 1	Outflow filter dirty	Clean or replace the filter
cd 2	Slow heating of the upper surface of the chamber	Perform a cycle with reduced load. In case, call for a technical service. Verify the mains voltage.
cd 3	Slow heating of the lower surface of the chamber	Perform a cycle with reduced load. In case, call for a technical service. Verify the mains voltage.
cd 4	Water dose distributor blocked H ₂ O filter dirty	Impurities in the main tank. Carry out the H ₂ O filter maintenance. Carry out the standard cleaning cycle!
cd 5	Water charge valve dirty	If the problem occurs more than 3 times, call for a technical service
cd 6	Bacterial filter clogged	Replace the filter
cd 7	Vacuum phase too slow	Wipe the chamber and perform a cleaning cycle

8.3 ABORTED CYCLE ALARMS

The alarms listed in Table C signal a detected fault that prevent the sterilization process from being completed. Identify the fault and the recommended action on the table.

The alarm condition is signaled by the lighting of the Led ALARM, and on the upper display by the flashing message FAIL followed by the code number of the detected alarm.

Example: FAIL AL 6

TABLE C

Alarm code	Cause	Recommended solution
AL 1	Fault of the electrovalve 1	Call for a technical service
AL 2	Fault of the electrovalve 2	Call for a technical service
AL 3	Fault of the electrovalve 3	Call for a technical service
AL 4	Fault of the electrovalve 4	Call for a technical service
AL 5	The pressure has not reached the set-point value within the preset time	Excess of load or pressure leakage. Carry out the cleaning cycle
AL 6	Too long time during the initial vacuum phase	Perform the cleaning cycle
AL 7	The door was opened after the start of the cycle	Make sure that the door is correctly closed.
AL 8	Air into the sterilization chamber	Verify the door tightness. Clean the gasket.
AL 9	Interruption of the countdown for over 60 sec. during the sterilization phase	Verify the door tightness. Perform the cleaning cycle and, if needed, clean the door gasket. Perform the vacuum test
AL 10	Too high pressure	Call for a technical service.
AL 11	Too low pressure	Verify the door tightness. Perform the cleaning cycle, if needed. Perform the vacuum test
AL 12	Temperature out the normal range	Perform the cleaning cycle
AL 13	Fault of the chamber temperature sensor	Call for a technical service
AL 14	Fault of the temperature upper sensor	Call for a technical service
AL 15	Fault of the temperature lower sensor	Call for a technical service
AL 16	Fault of the pressure sensor	Call for a technical service

ENGLISH

8.4 CLASS B ADDITIONAL ALARMS

TABLE D

Alarm code	Phase involved	Cause	Recommended solution
18	Drying phase	Drying interrupted	Dry the instruments
31	Drying phase	Vacuum not sufficient	Excess of load

NOTE: The Class B alarms may occur in the programs 1, 2, S2, S3 and S4 only.